



CEILING SPEAKER

L-507THS SPECIFICATION



General Specification	
Type	L-507THS
Frequency Response	100-20KHz
Sensitivity(1M/1W)	87±3dB
Rated power	20W
Power Taps	20W/10W/5W/2.5W&8Ω
Line input	100V/70V
Hole for mounting	Φ170mm
Dimension(L*W*H)(mm)	Φ203*150
Physical Specification	
Material(panel)	ABS
Material(cover)	IRON
Grille	Powder Coated Iron Mesh
Component(L.Speaker)	5" PP Woofer(foam edge)
Component(H.Speaker)	1/2" Mylar(rotatable)
Finished Colour	White
Unit Weight	1.8Kg
Gross Weight	18.4Kg/8PCS
Packing Dimension	54*50*42cm
Woofer Speaker Specification	
Voice Coil Size	Φ25.9*0.17*2Layer
DC Impedance	7.2 Ω
Former	ASV
Magnet	Ferrite(305g)
	Φ80*Φ32*15(Y30)
Basket	Iron
Cone Material	PP
Spider	Cloth
Net Weight	685g

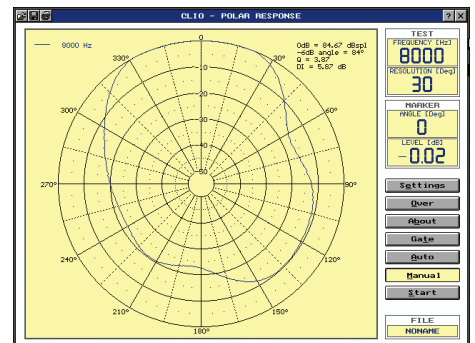
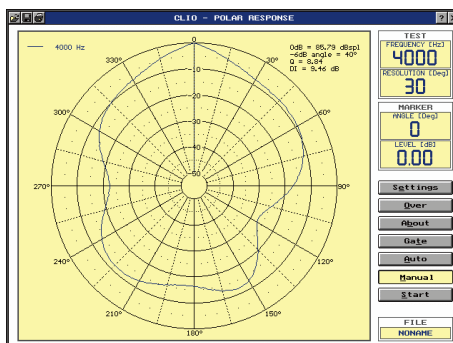
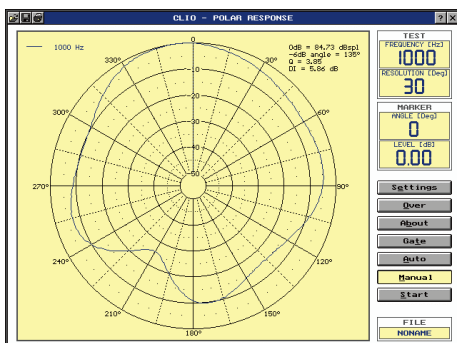
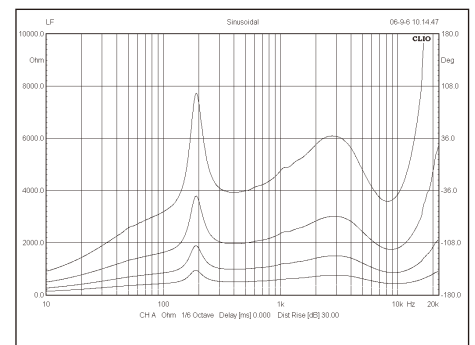
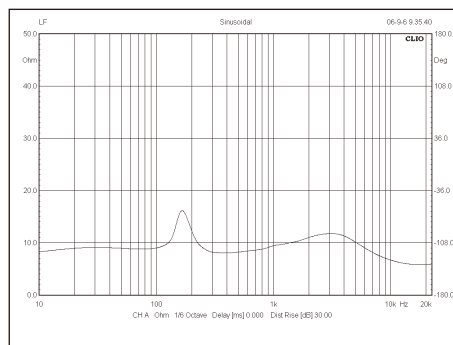
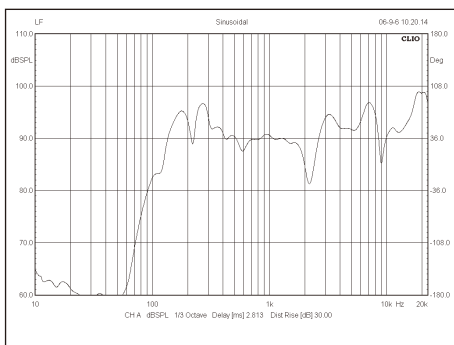
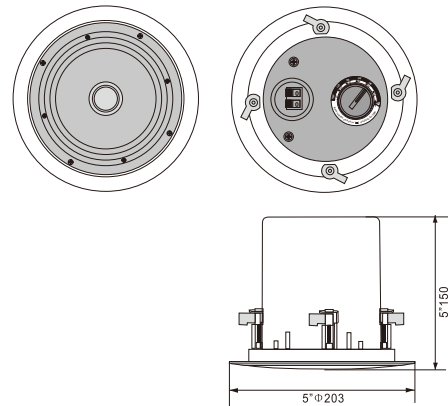



CEILING SPEAKER

L-607THS SPECIFICATION



General Specification	
Type	L-607THS
Frequency Response	90-20KHz
Sensitivity(1M/1W)	86±3dB
Rated power	30W
Power Taps	30W/15W/7.5W/3.8W&8Ω
Line input	100V/70V
Hole for mounting	Φ200mm
Dimension(L*W*H)(mm)	Φ230*150
Physical Specification	
Material(panel)	ABS
Material(cover)	IRON
Grille	Powder Coated Iron Mesh
Component(L.Speaker)	6" PP Woofer(foam edge)
Component(H.Speaker)	1/2" Mylar(rotatable)
Finished Colour	White
Unit Weight	2.3Kg
Gross Weight	21Kg/8PCS
Packing Dimension	59*55*43cm
Woofer Speaker Specification	
Voice Coil Size	Φ 25.9*0.17*2Layer
DC Impedance	7.2 Ω
Former	ASV
Magnet	Ferrite(400g)
	Φ90*Φ32*15(Y30)
Basket	Iron
Cone Material	PP
Spider	Cloth
Net Weight	980g

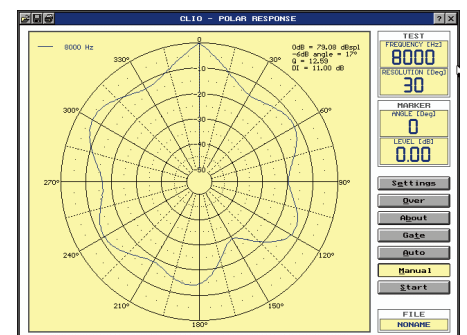
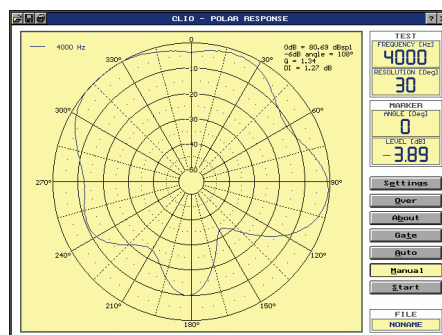
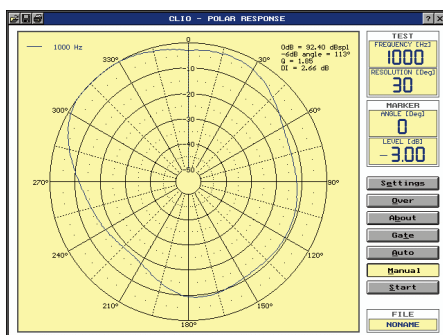
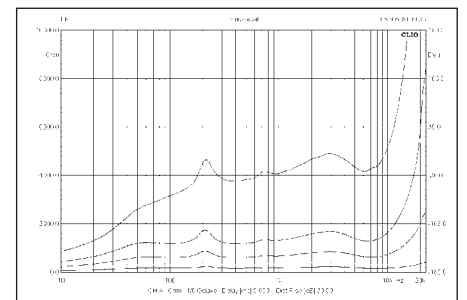
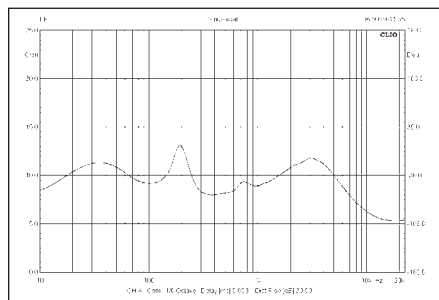
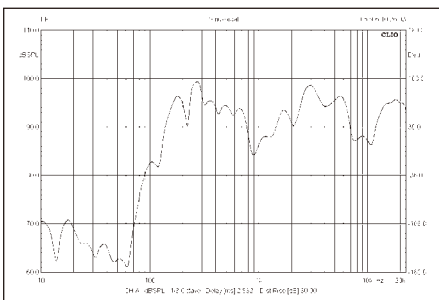
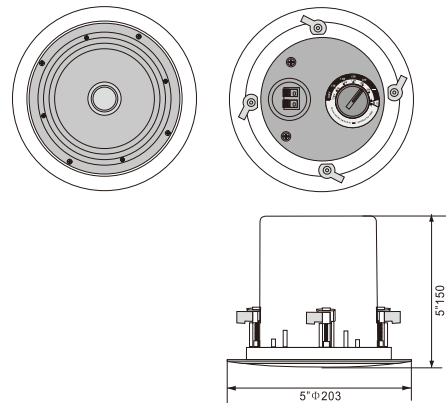



CEILING SPEAKER

L-807THS SPECIFICATION



General Specification	
Type	L-807THS
Frequency Response	90-20KHz
Sensitivity(1M/1W)	87±3dB
Rated power	40W
Power Taps	40W/20W/10W/5W&8Ω
Line input	100V/70V
Hole for mounting	Φ240mm
Dimension(L*W*H)(mm)	Φ270*170
Physical Specification	
Material(panel)	ABS
Material(cover)	IRON
Grille	Powder Coated Iron Mesh
Component(L.Speaker)	8" PP Woofer(foam edge)
Component(H.Speaker)	1/2" Mylar(rotatable)
Finished Colour	White
Unit Weight	3.1 Kg
Gross Weight	16Kg/4PCS
Packing Dimension	64*34*49cm
Woofer Speaker Specification	
Voice Coil Size	Φ25.9*0.17*2Layer
DC Impedance	7.2 Ω
Former	ASV
Magnet	Ferrite(619g)
	Φ100*Φ45*20(Y25)
Basket	Iron
Cone Material	PP
Spider	Cloth
Net Weight	1.4kg

